

PMBT3946YPN

40 V, 200 mA NPN/PNP general-purpose double transistor

Rev. 01 — 12 May 2009

Product data sheet

1. Product profile

1.1 General description

NPN/PNP general-purpose double transistor in a SOT363 (SC-88) very small Surface-Mounted Device (SMD) plastic package.

Table 1. Product overview

Type number	Package		NPN/NPN complement	PNP/PNP complement	Package configuration
	NXP	JEITA			
PMBT3946YPN	SOT363	SC-88	PMBT3904YS	PMBT3906YS	very small

1.2 Features

- General-purpose double transistor
- Board-space reduction

1.3 Applications

- General-purpose switching and amplification

1.4 Quick reference data

Table 2. Quick reference data

Symbol	Parameter	Conditions	Min	Typ	Max	Unit
Per transistor; for the PNP transistor with negative polarity						
V_{CEO}	collector-emitter voltage	open base	-	-	40	V
I_C	collector current		-	-	200	mA
h_{FE}	DC current gain	$V_{CE} = 1\text{ V};$ $I_C = 10\text{ mA}$	100	180	300	

2. Pinning information

Table 3. Pinning

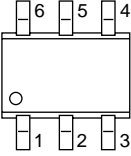
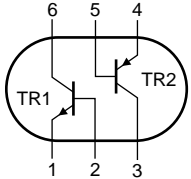
Pin	Description	Simplified outline	Graphic symbol
1	emitter TR1		
2	base TR1		
3	collector TR2		
4	emitter TR2		
5	base TR2		
6	collector TR1		

sym019

3. Ordering information

Table 4. Ordering information

Type number	Package		
	Name	Description	Version
PMBT3946YPN	SC-88	plastic surface-mounted package; 6 leads	SOT363

4. Marking

Table 5. Marking codes

Type number	Marking code ^[1]
PMBT3946YPN	BB*

- [1] * = -: made in Hong Kong
 * = p: made in Hong Kong
 * = t: made in Malaysia
 * = W: made in China

5. Limiting values

Table 6. Limiting values

In accordance with the Absolute Maximum Rating System (IEC 60134).

Symbol	Parameter	Conditions	Min	Max	Unit
TR1 (NPN)					
V_{CBO}	collector-base voltage	open emitter	-	60	V
TR2 (PNP)					
V_{CBO}	collector-base voltage	open emitter	-	-40	V
Per transistor; for the PNP transistor with negative polarity					
V_{CEO}	collector-emitter voltage	open base	-	40	V
V_{EBO}	emitter-base voltage	open collector	-	6	V
I_C	collector current		-	200	mA
I_{CM}	peak collector current	single pulse; $t_p \leq 1$ ms	-	200	mA
I_{BM}	peak base current	single pulse; $t_p \leq 1$ ms	-	100	mA
P_{tot}	total power dissipation	$T_{amb} \leq 25$ °C	[1]	230	mW
Per device					
P_{tot}	total power dissipation	$T_{amb} \leq 25$ °C	[1]	350	mW
T_j	junction temperature		-	150	°C
T_{amb}	ambient temperature		-55	+150	°C
T_{stg}	storage temperature		-65	+150	°C

[1] Device mounted on an FR4 Printed-Circuit Board (PCB), single-sided copper, tin-plated and standard footprint.

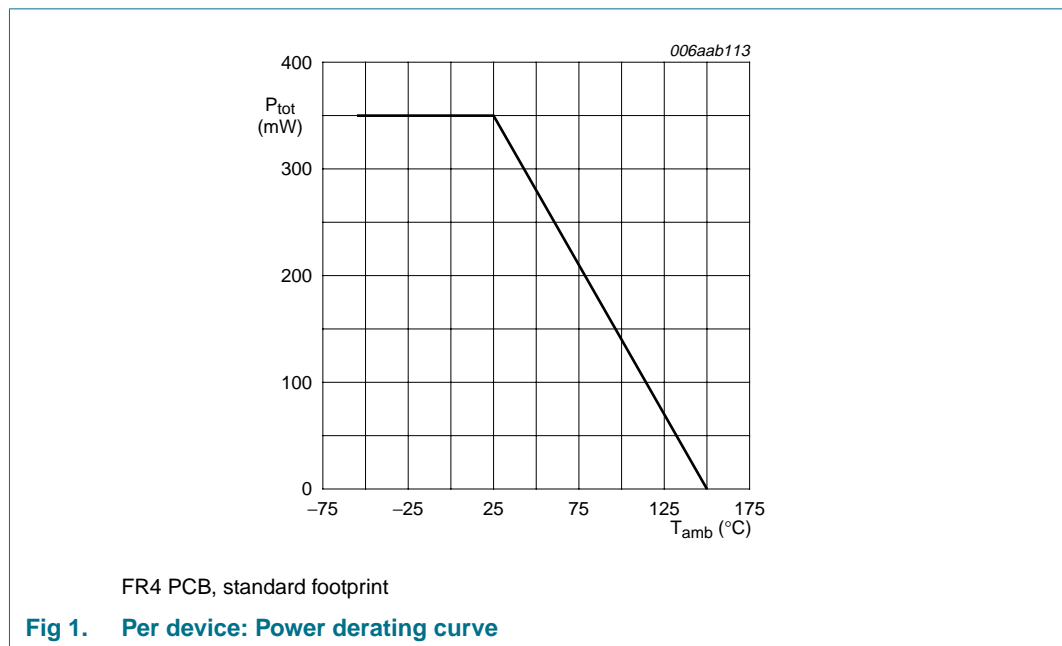

6. Thermal characteristics

Table 7. Thermal characteristics

Symbol	Parameter	Conditions	Min	Typ	Max	Unit
Per transistor						
$R_{th(j-a)}$	thermal resistance from junction to ambient	in free air	[1]	-	543	K/W
$R_{th(j-sp)}$	thermal resistance from junction to solder point		-	-	290	K/W
Per device						
$R_{th(j-a)}$	thermal resistance from junction to ambient	in free air	[1]	-	357	K/W

[1] Device mounted on an FR4 PCB, single-sided copper, tin-plated and standard footprint.

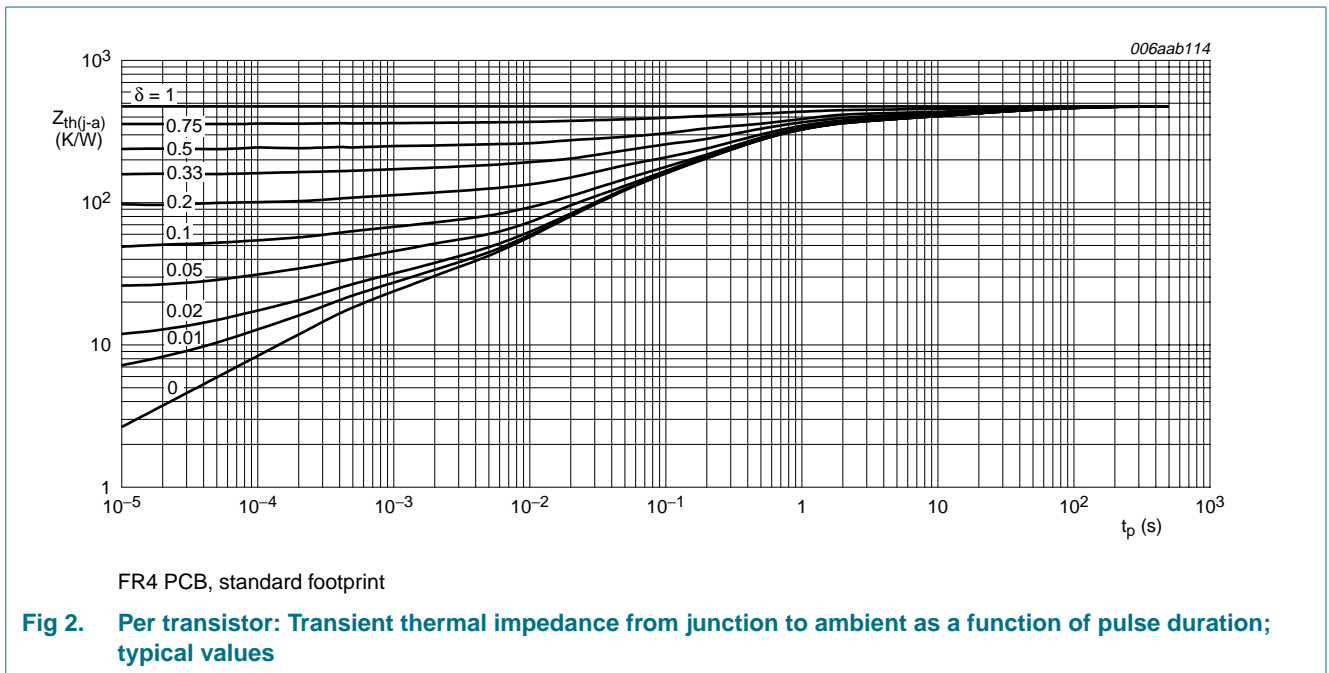

7. Characteristics

Table 8. Characteristics

$T_{amb} = 25\text{ }^{\circ}\text{C}$ unless otherwise specified.

Symbol	Parameter	Conditions	Min	Typ	Max	Unit
TR1 (NPN)						
I_{CBO}	collector-base cut-off current	$V_{CB} = 30\text{ V}; I_E = 0\text{ A}$	-	-	50	nA
I_{EBO}	emitter-base cut-off current	$V_{EB} = 6\text{ V}; I_C = 0\text{ A}$	-	-	50	nA
h_{FE}	DC current gain	$V_{CE} = 1\text{ V}$			-	
		$I_C = 0.1\text{ mA}$	60	180	-	
		$I_C = 1\text{ mA}$	80	180	-	
		$I_C = 10\text{ mA}$	100	180	300	
		$I_C = 100\text{ mA}$	30	50	-	
V_{CEsat}	collector-emitter saturation voltage	$I_C = 10\text{ mA}; I_B = 1\text{ mA}$	-	75	200	mV
		$I_C = 50\text{ mA}; I_B = 5\text{ mA}$	-	120	300	mV
V_{BEsat}	base-emitter saturation voltage	$I_C = 10\text{ mA}; I_B = 1\text{ mA}$	650	750	850	mV
		$I_C = 50\text{ mA}; I_B = 5\text{ mA}$	-	850	950	mV
f_T	transition frequency	$V_{CE} = 20\text{ V}; I_C = 10\text{ mA};$ $f = 100\text{ MHz}$	300	-	-	MHz
C_c	collector capacitance	$V_{CB} = 5\text{ V}; I_E = i_e = 0\text{ A};$ $f = 1\text{ MHz}$	-	-	4	pF
C_e	emitter capacitance	$V_{BE} = 0.5\text{ V}; I_C = i_c = 0\text{ A};$ $f = 1\text{ MHz}$	-	-	8	pF
NF	noise figure	$V_{CE} = 5\text{ V}; I_C = 100\text{ }\mu\text{A};$ $R_S = 1\text{ k}\Omega;$ $f = 10\text{ Hz to }15.7\text{ kHz}$	-	-	5	dB
t_d	delay time	$V_{CC} = 3\text{ V}; I_C = 10\text{ mA};$	-	-	35	ns
t_r	rise time	$I_{Bon} = 1\text{ mA}; I_{Boff} = -1\text{ mA}$	-	-	35	ns
t_{on}	turn-on time		-	-	70	ns
t_s	storage time		-	-	200	ns
t_f	fall time		-	-	50	ns
t_{off}	turn-off time		-	-	250	ns

Table 8. Characteristics ...continued
 $T_{amb} = 25^{\circ}\text{C}$ unless otherwise specified.

Symbol	Parameter	Conditions	Min	Typ	Max	Unit
TR2 (PNP)						
I_{CBO}	collector-base cut-off current	$V_{CB} = -30\text{ V}; I_E = 0\text{ A}$	-	-	-50	nA
I_{EBO}	emitter-base cut-off current	$V_{EB} = -6\text{ V}; I_C = 0\text{ A}$	-	-	-50	nA
h_{FE}	DC current gain	$V_{CE} = -1\text{ V}$				
		$I_C = -0.1\text{ mA}$	60	180	-	
		$I_C = -1\text{ mA}$	80	180	-	
		$I_C = -10\text{ mA}$	100	180	300	
		$I_C = -50\text{ mA}$	60	130	-	
V_{CEsat}	collector-emitter saturation voltage	$I_C = -10\text{ mA}; I_B = -1\text{ mA}$	-	-100	-250	mV
		$I_C = -50\text{ mA}; I_B = -5\text{ mA}$	-	-165	-400	mV
V_{BEsat}	base-emitter saturation voltage	$I_C = -10\text{ mA}; I_B = -1\text{ mA}$	-	-750	-850	mV
		$I_C = -50\text{ mA}; I_B = -5\text{ mA}$	-	-850	-950	mV
f_T	transition frequency	$V_{CE} = -20\text{ V}; I_C = -10\text{ mA};$ $f = 100\text{ MHz}$	250	-	-	MHz
C_c	collector capacitance	$V_{CB} = -5\text{ V}; I_E = i_e = 0\text{ A};$ $f = 1\text{ MHz}$	-	-	4.5	pF
C_e	emitter capacitance	$V_{CB} = -0.5\text{ V}; I_C = i_c = 0\text{ A};$ $f = 1\text{ MHz}$	-	-	10	pF
NF	noise figure	$V_{CE} = -5\text{ V}; I_C = -100\text{ }\mu\text{A};$ $R_S = 1\text{ k}\Omega;$ $f = 10\text{ Hz to }15.7\text{ kHz}$	-	-	4	dB
t_d	delay time	$V_{CC} = -3\text{ V}; I_C = -10\text{ mA};$	-	-	35	ns
t_r	rise time	$I_{Bon} = -1\text{ mA}; I_{Boff} = 1\text{ mA}$	-	-	35	ns
t_{on}	turn-on time		-	-	70	ns
t_s	storage time		-	-	225	ns
t_f	fall time		-	-	75	ns
t_{off}	turn-off time		-	-	300	ns

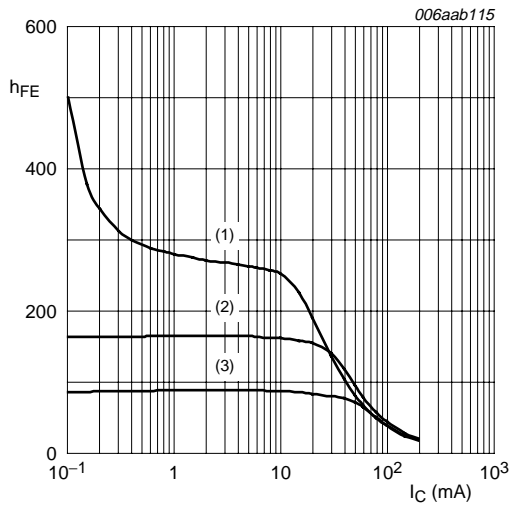

$V_{CE} = 1\text{ V}$
 (1) $T_{amb} = 150\text{ °C}$
 (2) $T_{amb} = 25\text{ °C}$
 (3) $T_{amb} = -55\text{ °C}$

Fig 3. TR1 (NPN): DC current gain as a function of collector current; typical values

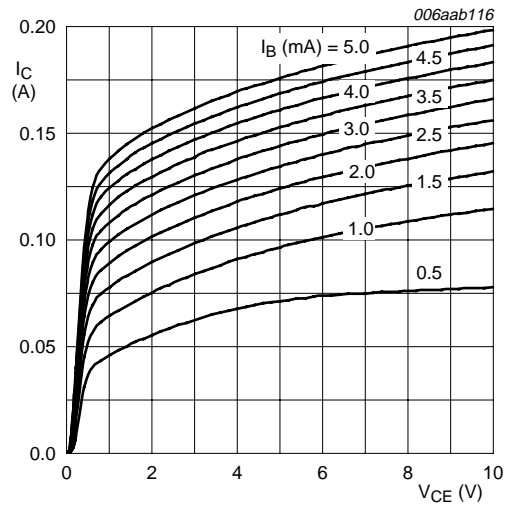

$T_{amb} = 25\text{ °C}$

Fig 4. TR1 (NPN): Collector current as a function of collector-emitter voltage; typical values

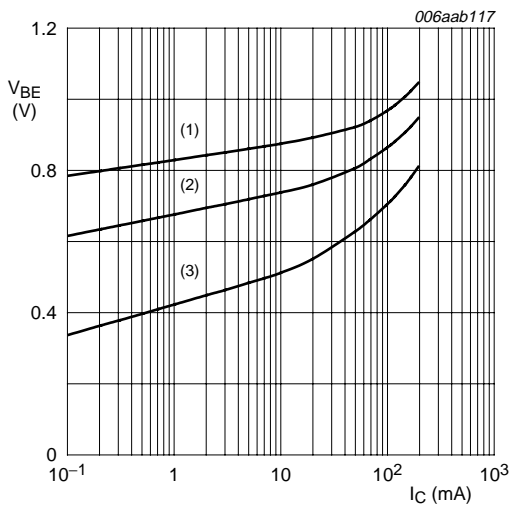

$V_{CE} = 1\text{ V}$
 (1) $T_{amb} = -55\text{ °C}$
 (2) $T_{amb} = 25\text{ °C}$
 (3) $T_{amb} = 150\text{ °C}$

Fig 5. TR1 (NPN): Base-emitter voltage as a function of collector current; typical values

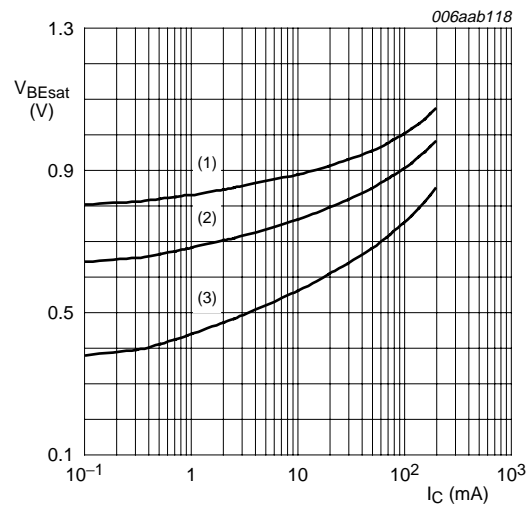

$I_C/I_B = 10$
 (1) $T_{amb} = -55\text{ °C}$
 (2) $T_{amb} = 25\text{ °C}$
 (3) $T_{amb} = 150\text{ °C}$

Fig 6. TR1 (NPN): Base-emitter saturation voltage as a function of collector current; typical values

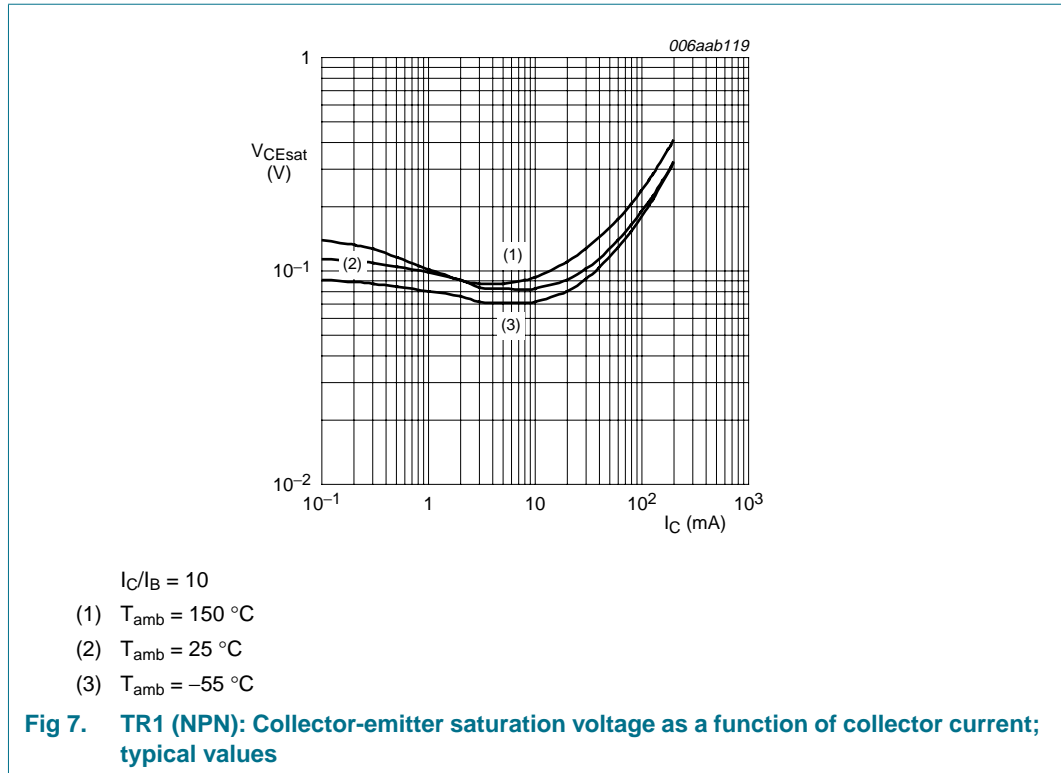

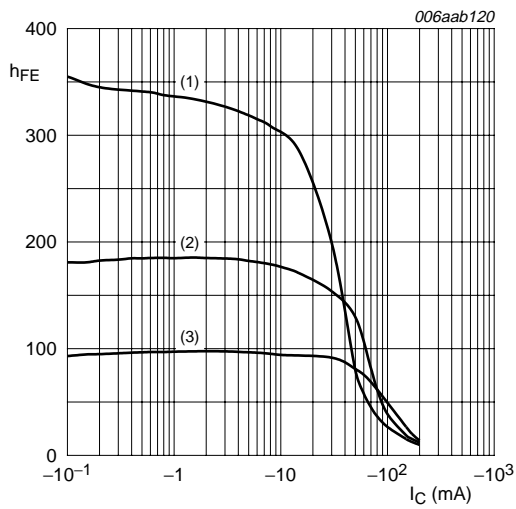

$V_{CE} = -1\text{ V}$
 (1) $T_{amb} = 150\text{ °C}$
 (2) $T_{amb} = 25\text{ °C}$
 (3) $T_{amb} = -55\text{ °C}$

Fig 8. TR2 (PNP): DC current gain as a function of collector current; typical values

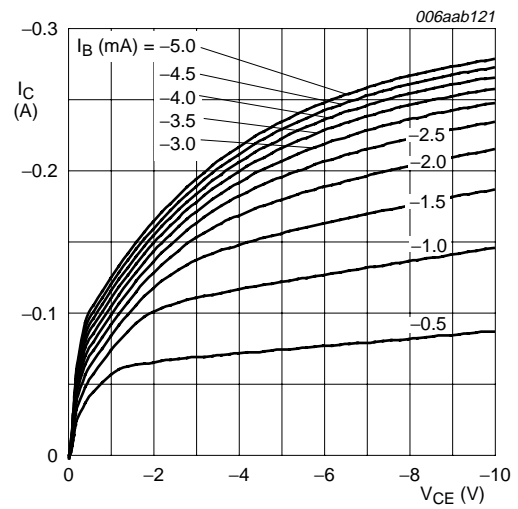

$T_{amb} = 25\text{ °C}$

Fig 9. TR2 (PNP): Collector current as a function of collector-emitter voltage; typical values

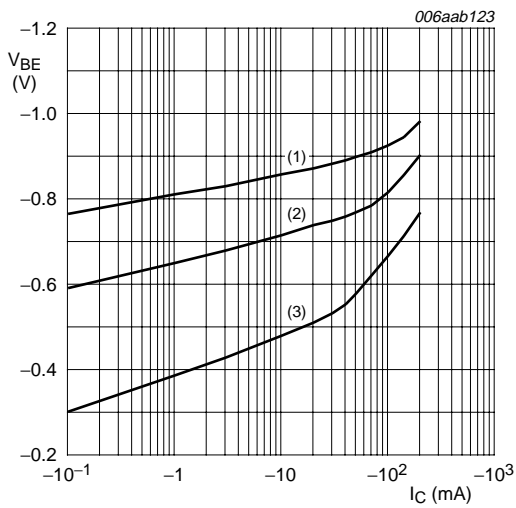

$V_{CE} = -1\text{ V}$
 (1) $T_{amb} = -55\text{ °C}$
 (2) $T_{amb} = 25\text{ °C}$
 (3) $T_{amb} = 150\text{ °C}$

Fig 10. TR2 (PNP): Base-emitter voltage as a function of collector current; typical values

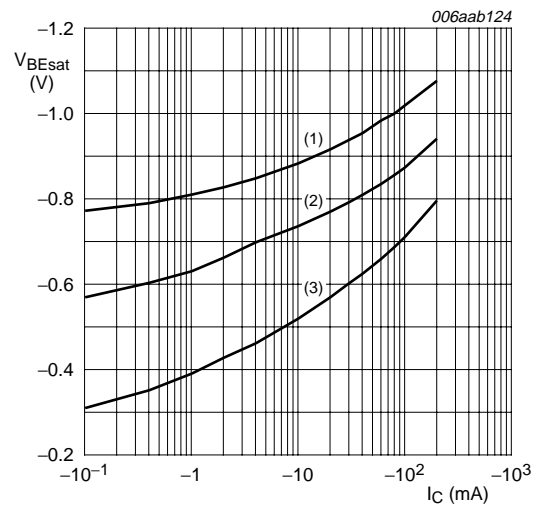

$I_C/I_B = 10$
 (1) $T_{amb} = -55\text{ °C}$
 (2) $T_{amb} = 25\text{ °C}$
 (3) $T_{amb} = 150\text{ °C}$

Fig 11. TR2 (PNP): Base-emitter saturation voltage as a function of collector current; typical values

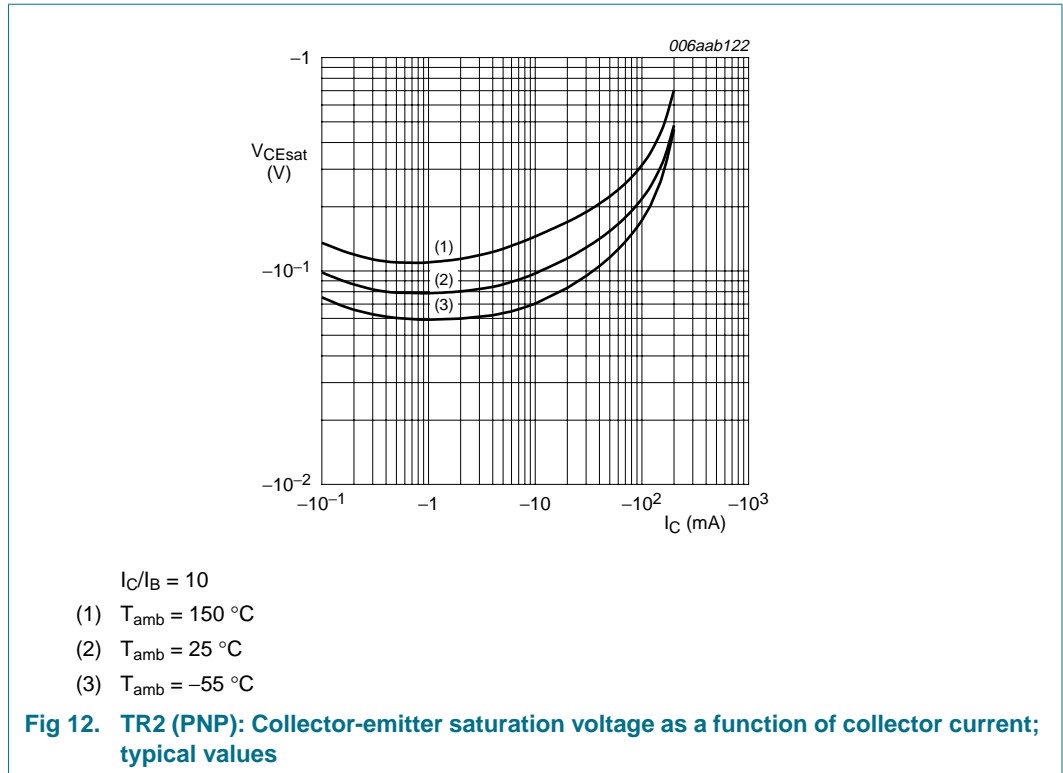

8. Test information

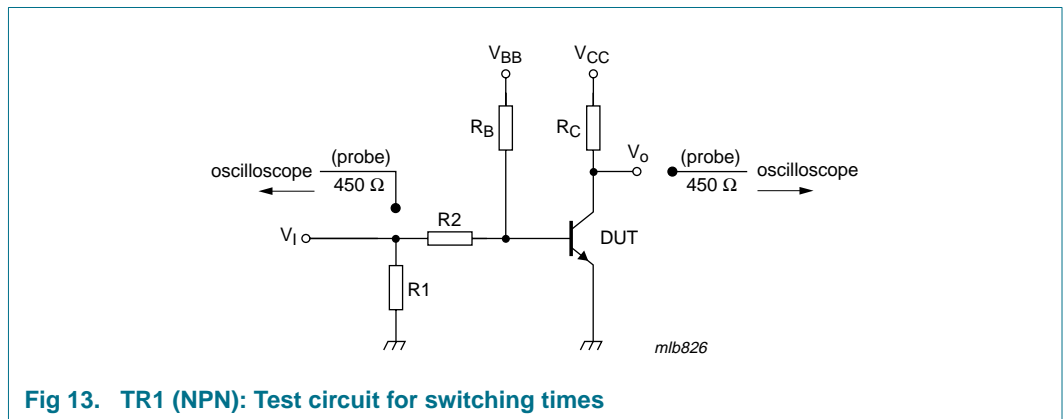

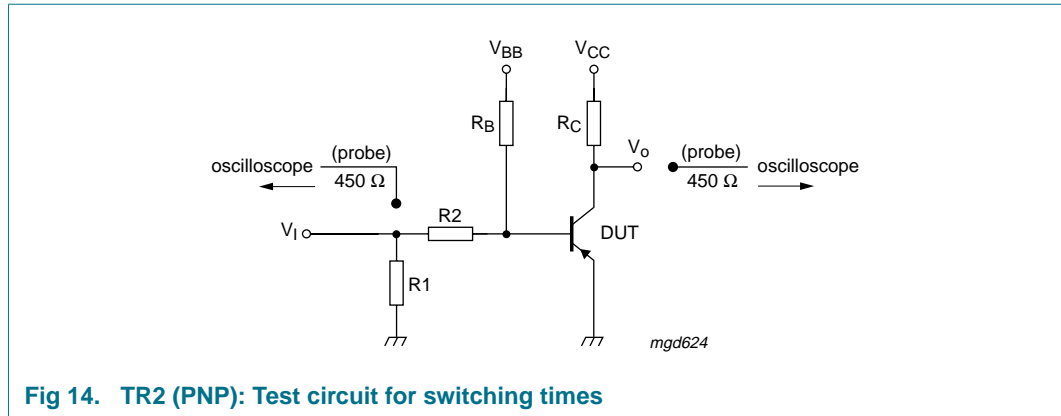

9. Package outline

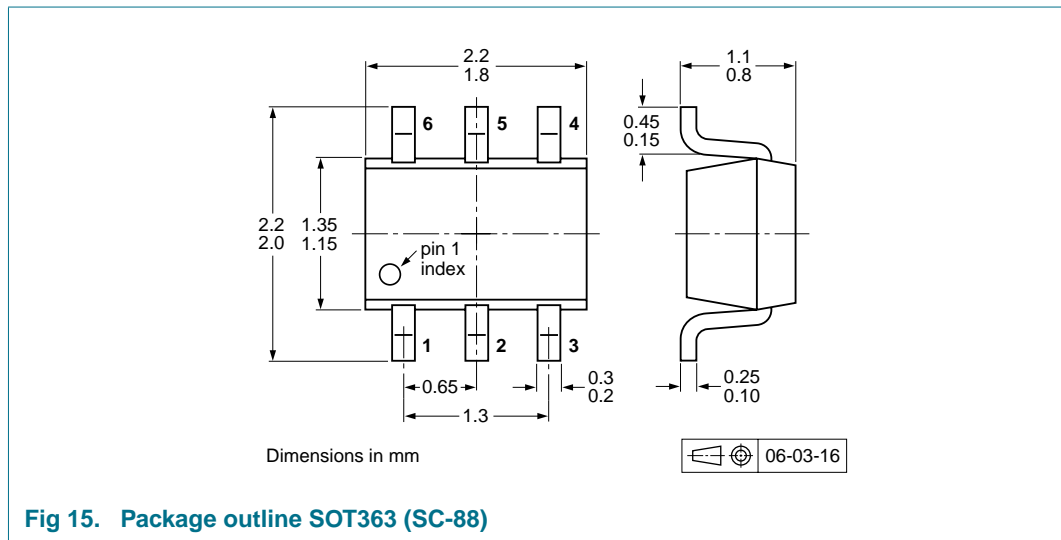

10. Packing information

Table 9. Packing methods

The indicated -xxx are the last three digits of the 12NC ordering code.^[1]

Type number	Package	Description	Packing quantity	
			3000	10000
PMBT3946YPN	SOT363	4 mm pitch, 8 mm tape and reel; T1	^[2] -115	-135
		4 mm pitch, 8 mm tape and reel; T2	^[3] -125	-165

[1] For further information and the availability of packing methods, see [Section 14](#).

[2] T1: normal taping

[3] T2: reverse taping

11. Soldering

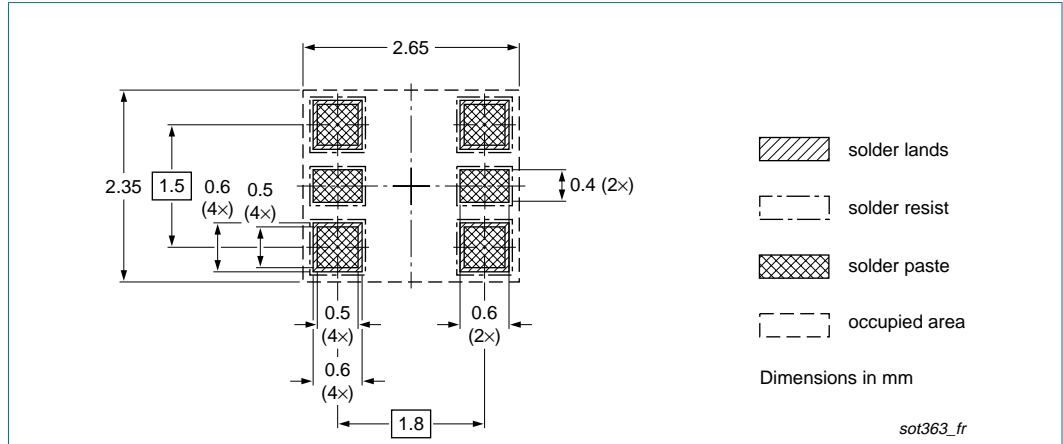

Fig 16. Reflow soldering footprint SOT363 (SC-88)

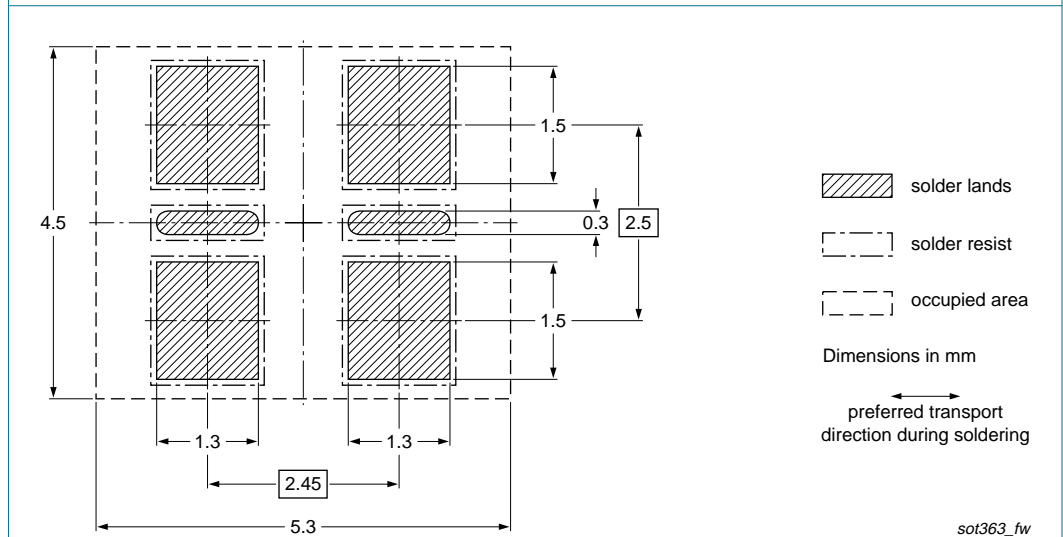

Fig 17. Wave soldering footprint SOT363 (SC-88)

12. Revision history

Table 10. Revision history

Document ID	Release date	Data sheet status	Change notice	Supersedes
PMBT3946YPN_1	20090512	Product data sheet	-	-

13. Legal information

13.1 Data sheet status

Document status ^{[1][2]}	Product status ^[3]	Definition
Objective [short] data sheet	Development	This document contains data from the objective specification for product development.
Preliminary [short] data sheet	Qualification	This document contains data from the preliminary specification.
Product [short] data sheet	Production	This document contains the product specification.

[1] Please consult the most recently issued document before initiating or completing a design.

[2] The term 'short data sheet' is explained in section "Definitions".

[3] The product status of device(s) described in this document may have changed since this document was published and may differ in case of multiple devices. The latest product status information is available on the Internet at URL <http://www.nxp.com>.

13.2 Definitions

Draft — The document is a draft version only. The content is still under internal review and subject to formal approval, which may result in modifications or additions. NXP Semiconductors does not give any representations or warranties as to the accuracy or completeness of information included herein and shall have no liability for the consequences of use of such information.

Short data sheet — A short data sheet is an extract from a full data sheet with the same product type number(s) and title. A short data sheet is intended for quick reference only and should not be relied upon to contain detailed and full information. For detailed and full information see the relevant full data sheet, which is available on request via the local NXP Semiconductors sales office. In case of any inconsistency or conflict with the short data sheet, the full data sheet shall prevail.

13.3 Disclaimers

General — Information in this document is believed to be accurate and reliable. However, NXP Semiconductors does not give any representations or warranties, expressed or implied, as to the accuracy or completeness of such information and shall have no liability for the consequences of use of such information.

Right to make changes — NXP Semiconductors reserves the right to make changes to information published in this document, including without limitation specifications and product descriptions, at any time and without notice. This document supersedes and replaces all information supplied prior to the publication hereof.

Suitability for use — NXP Semiconductors products are not designed, authorized or warranted to be suitable for use in medical, military, aircraft, space or life support equipment, nor in applications where failure or malfunction of an NXP Semiconductors product can reasonably be expected to result in personal injury, death or severe property or environmental

damage. NXP Semiconductors accepts no liability for inclusion and/or use of NXP Semiconductors products in such equipment or applications and therefore such inclusion and/or use is at the customer's own risk.

Applications — Applications that are described herein for any of these products are for illustrative purposes only. NXP Semiconductors makes no representation or warranty that such applications will be suitable for the specified use without further testing or modification.

Limiting values — Stress above one or more limiting values (as defined in the Absolute Maximum Ratings System of IEC 60134) may cause permanent damage to the device. Limiting values are stress ratings only and operation of the device at these or any other conditions above those given in the Characteristics sections of this document is not implied. Exposure to limiting values for extended periods may affect device reliability.

Terms and conditions of sale — NXP Semiconductors products are sold subject to the general terms and conditions of commercial sale, as published at <http://www.nxp.com/profile/terms>, including those pertaining to warranty, intellectual property rights infringement and limitation of liability, unless explicitly otherwise agreed to in writing by NXP Semiconductors. In case of any inconsistency or conflict between information in this document and such terms and conditions, the latter will prevail.

No offer to sell or license — Nothing in this document may be interpreted or construed as an offer to sell products that is open for acceptance or the grant, conveyance or implication of any license under any copyrights, patents or other industrial or intellectual property rights.

Quick reference data — The Quick reference data is an extract of the product data given in the Limiting values and Characteristics sections of this document, and as such is not complete, exhaustive or legally binding.

Export control — This document as well as the item(s) described herein may be subject to export control regulations. Export might require a prior authorization from national authorities.

13.4 Trademarks

Notice: All referenced brands, product names, service names and trademarks are the property of their respective owners.

14. Contact information

For more information, please visit: <http://www.nxp.com>

For sales office addresses, please send an email to: salesaddresses@nxp.com

15. Contents

1	Product profile	1
1.1	General description	1
1.2	Features	1
1.3	Applications	1
1.4	Quick reference data	1
2	Pinning information	2
3	Ordering information	2
4	Marking	2
5	Limiting values	3
6	Thermal characteristics	4
7	Characteristics	5
8	Test information	10
9	Package outline	11
10	Packing information	11
11	Soldering	12
12	Revision history	13
13	Legal information	14
13.1	Data sheet status	14
13.2	Definitions	14
13.3	Disclaimers	14
13.4	Trademarks	14
14	Contact information	14
15	Contents	15

Please be aware that important notices concerning this document and the product(s) described herein, have been included in section 'Legal information'.



© NXP B.V. 2009.

All rights reserved.

For more information, please visit: <http://www.nxp.com>

For sales office addresses, please send an email to: salesaddresses@nxp.com

Date of release: 12 May 2009

Document identifier: PMBT3946YPN_1